











INSTALL THE PRODUCT – PRECAST FACTORY

Identification of the product

SUMO Wall Shoes are available in standard models analogous to the M-thread sizes of the HPM and PPM Anchor Bolts. The model of the wall shoe can be identified by the name on the product's label and also according to the color of the product. The color codes are shown in the table below.

SUMO Wall Shoe with corresponding Peikko Anchor Bolts.

Wall Shoe	Anchor Bolt	Color Code
SUMO 16H	HPM 16 + AL 16	 Yellow
SUMO 20H	HPM 20 + AL 20	 Blue
SUMO 24H	HPM 24 + AL 24	 Gray
SUMO 30H	HPM 30 + AL 30	 Green
SUMO 39H	HPM 39 + AL 39	 Orange
SUMO 30P	PPM 30 + AL 30	 Black
SUMO 36P	PPM 36 + AL 36	 Red
SUMO 39P	PPM 39 + AL 39	 Brown
SUMO 45P	PPM 45 + AL 45	 Purple
SUMO 52P	PPM 52 + AL 52	 White



Installation of the wall shoes

The SUMO Wall Shoes are placed into the reinforcement of the wall and attached to the mold. This could be done using bolts or clamps. Supplementary reinforcement must be provided in accordance with Appendix A. The maximum installation tolerances of the wall shoe in the precast wall element are given in the below table.

Installation tolerance of wall shoe and anchor bolt [mm].

Wall Shoe	SUMO 16H	SUMO 20H	SUMO 24H	SUMO 30H	SUMO 39H	SUMO 30P	SUMO 36P	SUMO 39P	SUMO 45P	SUMO 52P
Longitudinal direction	$T_{w,l}$	±5	±5	±5	±5	±5	±5	±5	±5	±5
Transversal direction	$T_{w,t}$	±2	±2	±3	±3	±3	±3	±3	±4	±4

Anchor Bolt	HPM 16	HPM 20	HPM 24	HPM 30	HPM 39	PPM 30	PPM 36	PPM 39	PPM 45	PPM 52
Protrusion of the bolt	h_b	100	110	115	135	145	165	185	195	220
Installation tolerance for the single bolt	T^*	±3	±3	±3	±3	±3	±4	±4	±4	±5

*The installation tolerances for bolts are in accordance with the technical manual for HPM and PPM Anchor Bolts

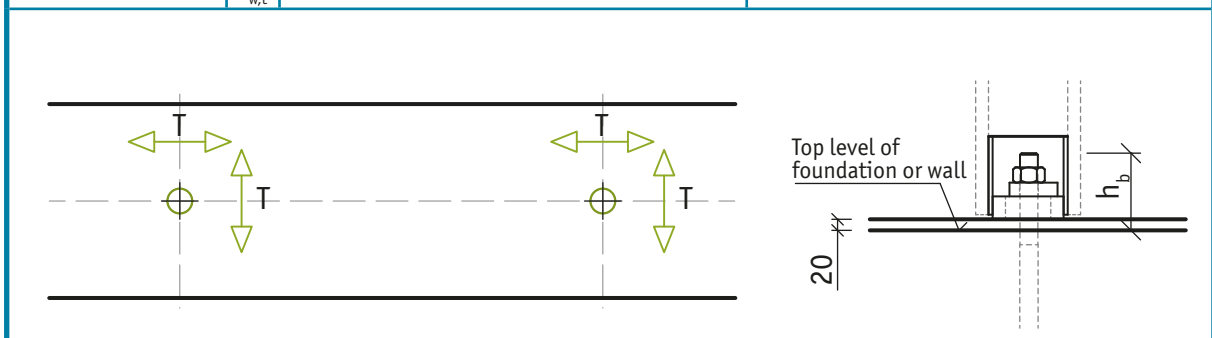
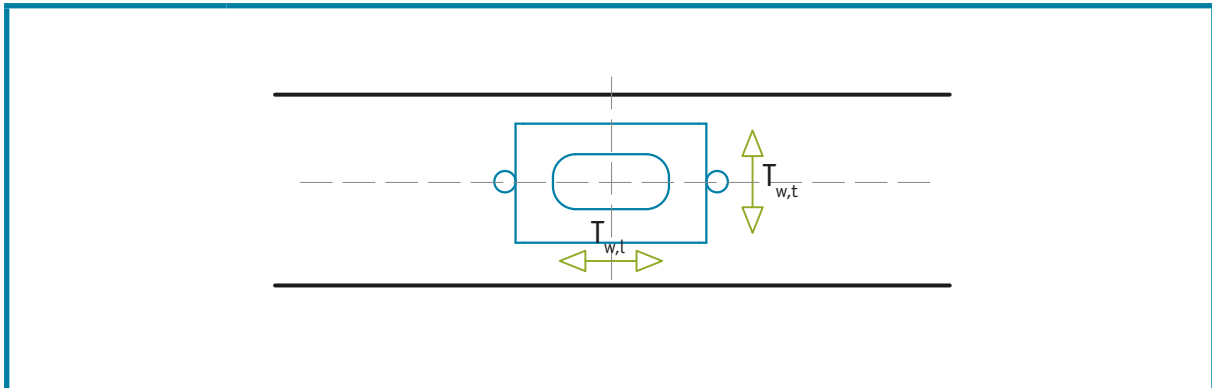











INSTALL THE PRODUCT – CONSTRUCTION SITE

Identification of the product

SUMO Wall Shoes are available in standard models analogous to the M-thread sizes of the HPM and PPM Anchor Bolts. The model of the wall shoe can be identified by the name on the product's label and also according to the color of the product. The color codes are shown in the table below.

SUMO Wall Shoe color identification.

Wall Shoe	Anchor Bolt	Color Code
SUMO 16H	HPM 16 + AL 16	 Yellow
SUMO 20H	HPM 20 + AL 20	 Blue
SUMO 24H	HPM 24 + AL 24	 Gray
SUMO 30H	HPM 30 + AL 30	 Green
SUMO 39H	HPM 39 + AL 39	 Orange
SUMO 30P	PPM 30 + AL 30	 Black
SUMO 36P	PPM 36 + AL 36	 Red
SUMO 39P	PPM 39 + AL 39	 Brown
SUMO 45P	PPM 45 + AL 45	 Purple
SUMO 52P	PPM 52 + AL 52	 White



Erection of precast walls

The precast wall element is erected to the correct height with the help of shim plates. The element must be supported with temporary braces. The element must be checked to ensure that it is in the right position before the nuts are tightened using a slog ring spanner (DIN 7444) and a 1.5 kg sledgehammer or equivalent. As the nuts are tightened, the washer must be turned inside the recess area. The lower joint of the element can be grouted afterwards or the element can be erected on fresh non-shrinking mortar. Before the upper structures are erected, the joint underneath the wall and bolt recesses should be grouted by following the instructions of the grout material provider. The grout must be of a non-shrinking type. After the grouting has reached sufficient strength, the connection is finalized.



Erection of a precast concrete wall step by step.

The wall is installed on pre-leveled shim plates

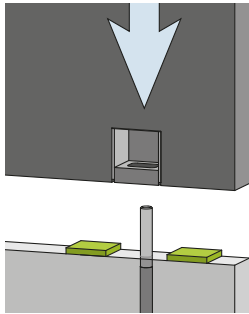

The nuts and washers are screwed on and tightened.

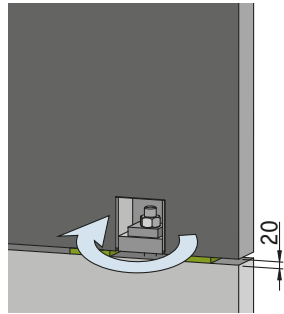

The connection is ready for grouting

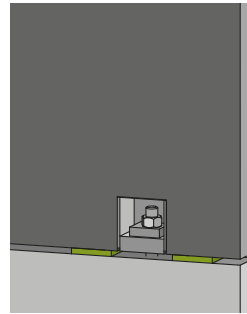

The finalized connection after the grouting has hardened

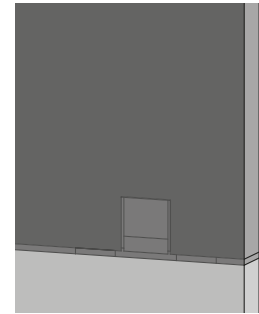

Installation tolerance of precast wall and anchor bolt [mm].

Wall Shoe		SUMO 16H	SUMO 20H	SUMO 24H	SUMO 30H	SUMO 39H	SUMO 30P	SUMO 36P	SUMO 39P	SUMO 45P	SUMO 52P
Tolerances of precast wall in longitudinal direction	$T_{c,l}$ [mm]	±20	±20	±20	±20	±20	±20	±20	±20	±20	±20
Tolerances of precast wall in transversal direction	$T_{c,t}$ [mm]	±5	±5	±5	±5	±5	±5	±5	±5	±6	±6

Anchor Bolt		HPM 16	HPM 20	HPM 24	HPM 30	HPM 39	PPM 30	PPM 36	PPM 39	PPM 45	PPM 52
Protrusion of the bolt	h_b	100	110	115	135	160	145	165	185	195	220
Installation tolerance for the single bolt	T^*	±3	±3	±3	±3	±3	±3	±4	±4	±4	±5

*The installation tolerances for bolts are in accordance with the technical manual for HPM and PPM Anchor Bolts

